



- EC
-



Coffee grinders - Fruit juicers - Mixers - Blenders - Drinks dispensers - Planetary mixers
Cheese graters - Ice crushers - Mincers - Vegetable slicers – Dough mixer

INTERNATIONALLY PATENTED MODELS



“UE/CE”	3
.....	4
.....	4
.....	4
.....	4
.....	5
.....	5
.....	5
#65	6
.....	6
.....	6
.....	6
.....	6
.....	6
.....	6
.....	7
.....	7
.....	7
.....	7
.....	7
.....	7
.....	7
/	8
.....	8
.....	8
.....	8
.....	9
.....	9
.....	9
.....	9
.....	9
.....	9
.....	10
.....	10
.....	11
.....	11
.....	11
100 - 120V 50/60Hz	12
220 - 240V 50/60Hz	13
.....	14
.....	15
.....	18
.....	18
.....	18

SANTOS SAS - Roger SALENGRO 140-150 69120 VAULX-EN-VELIN

原汁机 Nutrisantos 65

- “ ” 2006/42/EC 1
- - 2014/35/EU
 - 2014/30/EU EMC
 - 2011/65/EU RoHS
 - 2012/19/EU WEEE
 - 1935/2004/EC ()
 - 10/2011/EC ()
- NF EN 1678+A1 2010 - -
- EN ISO 12100 C C “ ” A B
C 2006/42/EC
ZA
- NF EN ISO 12100 :2010 -
- NF EN 60204-1+A1 :2009 - -
- NF EN 1672-2+A1 :2009 - -
- NF EN 60335-1 2013
- Pr NF EN 60335-2-64 2015

VAULX-EN-VELIN 2018/3/1

Aurélien FOUQUET

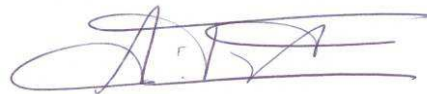



2

90 cm

:

(13)



- 1.
- 2.
- 3.
- 4.
- 5.
- 6.
- 7.
- 8.
- 9.
- 10.
- 11.
- 12.
- 13.
- 14.
- 15.
- 16.
- 17.
- 18.

10°

4

SANTOS

SANTOS

SANTOS

- 2
- 220-240V 50/60 Hz monophasé
 - 110-120V 50/60 Hz monophasé

2 +

16A

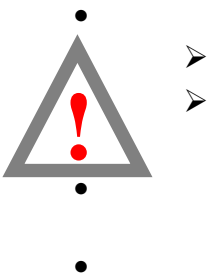

(22)

SANTOS

SANTOS

- | | | | | | | | | |
|----|------|------|------|------|------|------|------|--|
| 1. | | (6) | | (2) | 2 | | | |
| 2. | (2) | | | | | | | |
| 3. | | (1) | 3 | | | | | |
| 4. | | (11) | | | | | | |
| 5. | | (12) | | | | | | |
| 6. | (13) | 2 | (15) | | | | | |
| 7. | (17) | | | (18) | (19) | 4 | | |
| 8. | | | | (4) | | (3) | (1) | |
| | (11) | (12) | (13) | (15) | (17) | (18) | (19) | |
| | (5) | 5 | | | | | | |



2012/19/EU (WEEE)

—

—

SANTOS

SANTOS

#65

-
-
- 2

1.	(15)	(13)	(1)	7	(1)	6
		(1)		(13)		
2.	(1)		(17)	(19)	(18)	9 10
3.	(1)					
4.		(12)	11			
		(12)	2	(15)	2	14
5.		(11)	12			
6.		(6)		(2)		
		(2)	(13)
		(11)	(12)		4	
7.	(3)	15				
8.	(5)					
9.		(22)		16		
10.	(3)		(4)			

1.	(1)	(9)	(4)	(5)
2.	/			
3.		(3)		
4.				

13
14 8

- 1. « / » (9)
- 2. (22)

3 3

(10)



(13)

(13

11/12

(23)

(16) (18) (20) (21) (23) (24) 17 9 22 20



(5)

(5)



2

15-30

(22)

SANTOS



(3)

(1)

(2)

(3)

(2)

« / » (9)

SANTOS

(13) (15) (16) (18) (20) (21)
www.santos.fr



- (11) (12) (13) (15) (4) (3) (1)
- (5) (17) (18) (19)

:



-
- (3) (2) 13

- " "



“ ”

-
- -

- EC

(V)	220-240	100-120
(Hz)	50 / 60	50 / 60
(kW)	0.5	0.5
(A)	2.5	5
/	5 - 10	5 - 10
/	35 - 70	35 - 70
	1	1
L _{Aeq} , dB, ref 20μPa	64	64
	10	10
	10	10
(mm)	642	
(mm)	236	
(mm)	412	
kg	28.6	
kg	32	
()	4	
(mm)	223	
	4°C	:50°C
	+1°C	+50°C

100 - 120V 50/60Hz

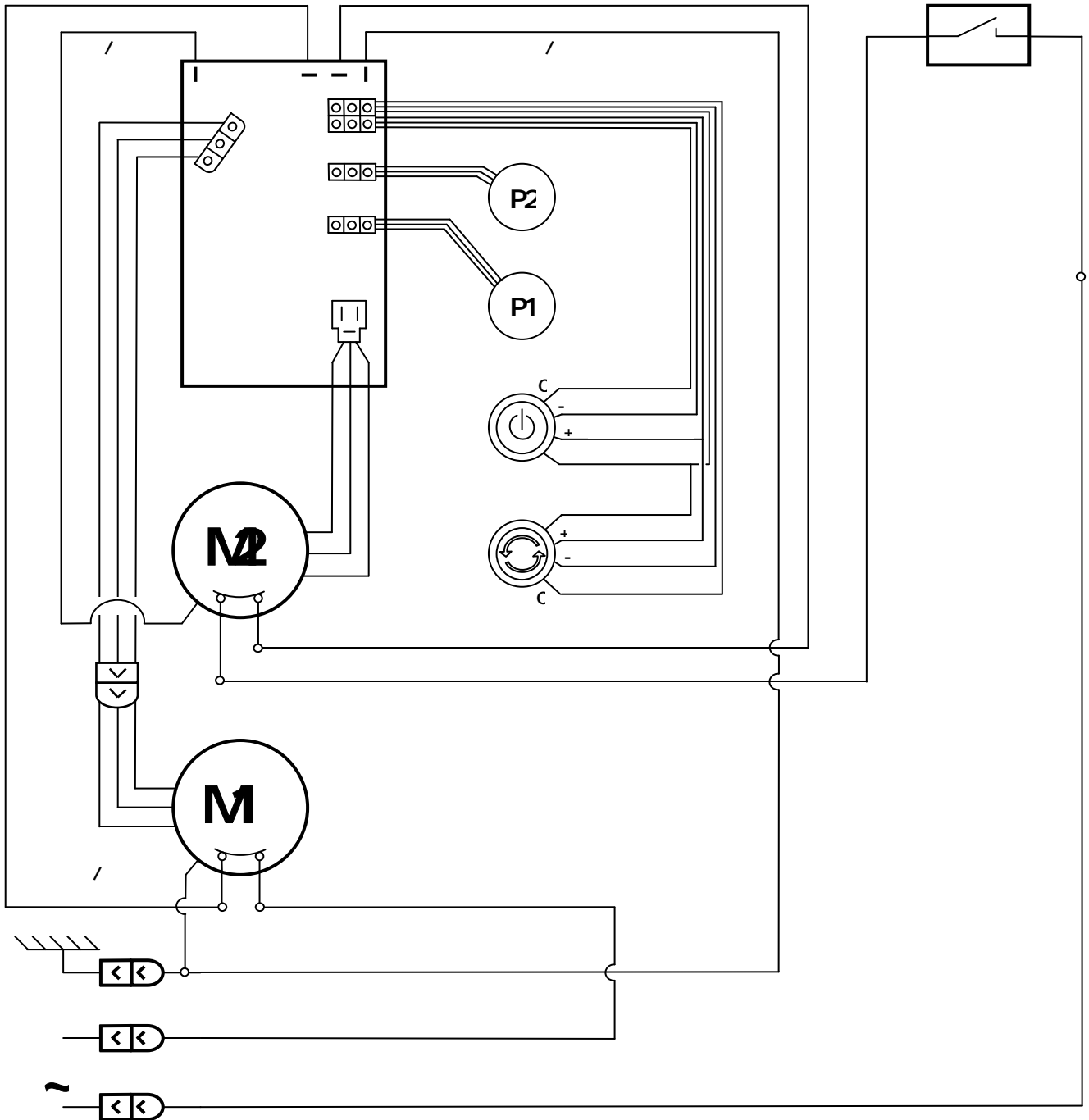

220 - 240V 50/60Hz

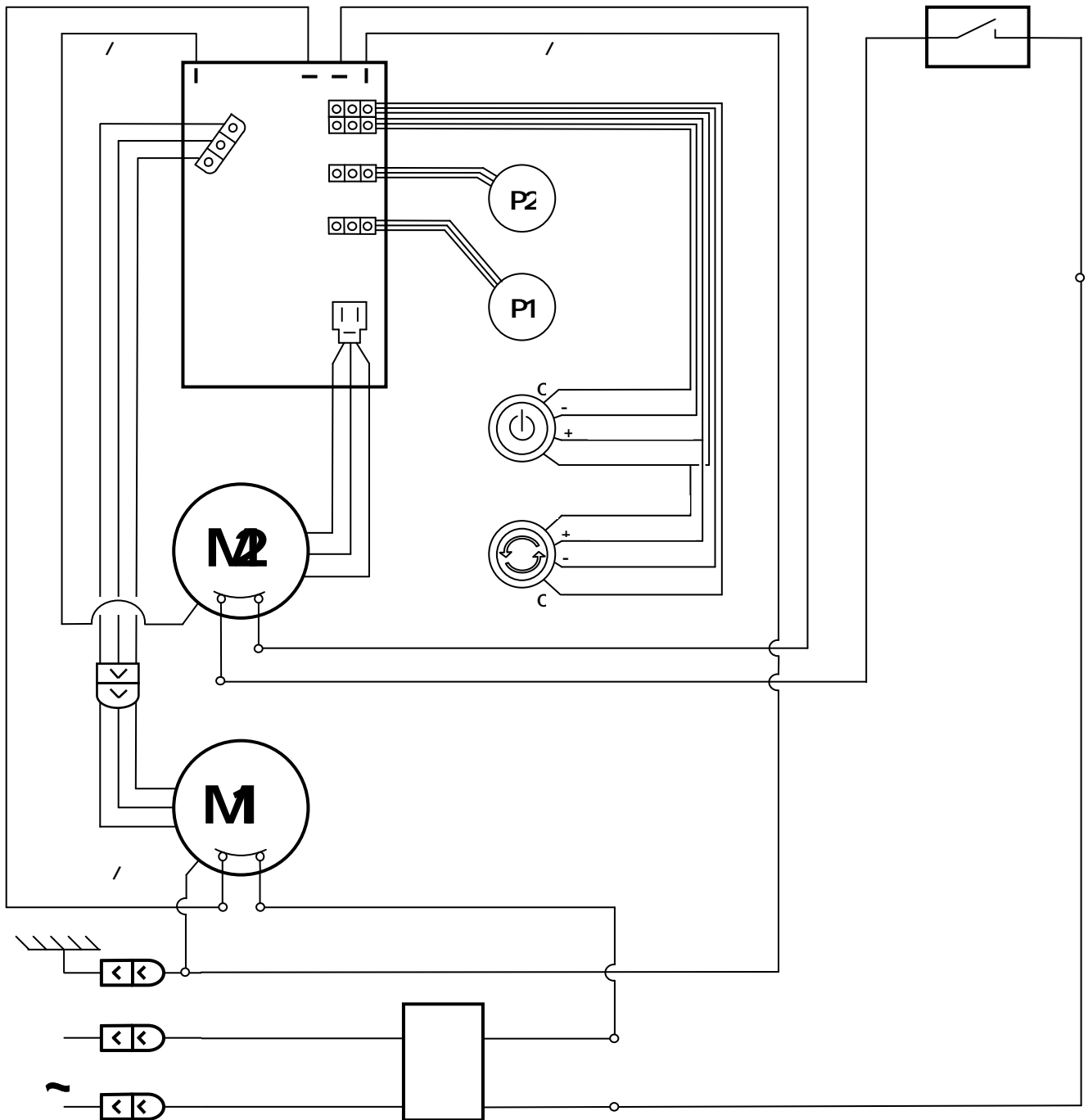

	F
1	
2	
3	
4	
5	
6	
7	
8	
9	" / "
10	" "
11	
12	
13	
14	65221 ()
15	
16	
17	
18	
19	
20	
21	
22	
23	
24	



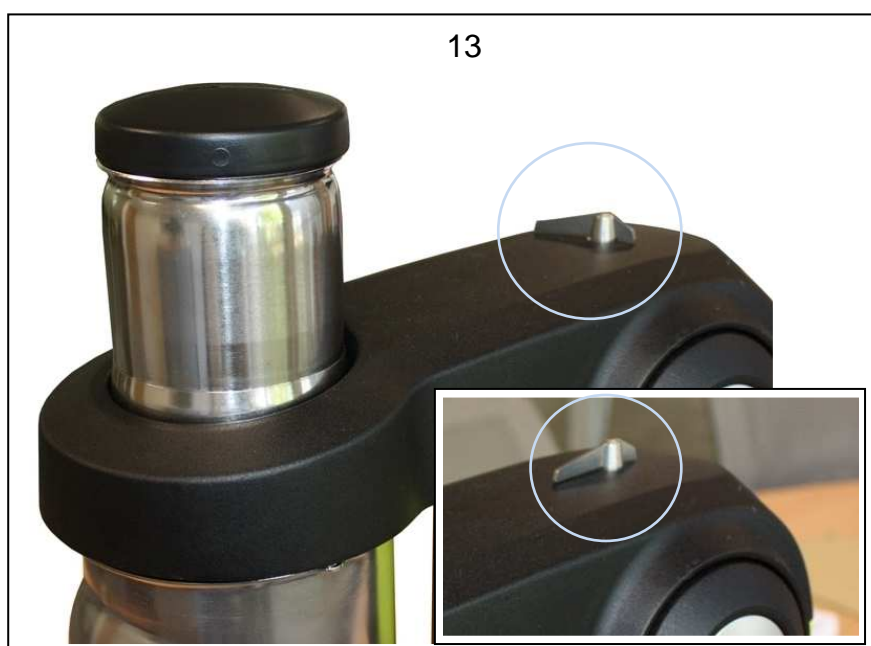
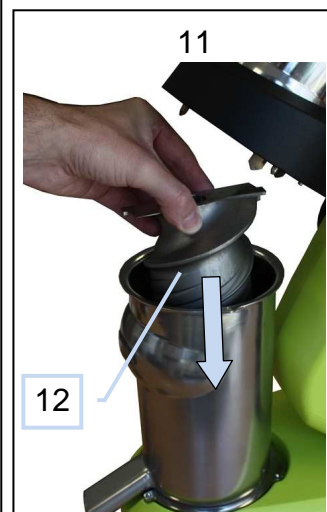
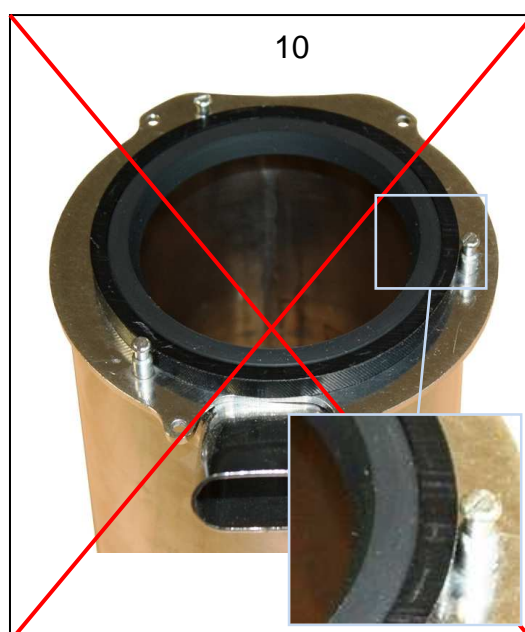
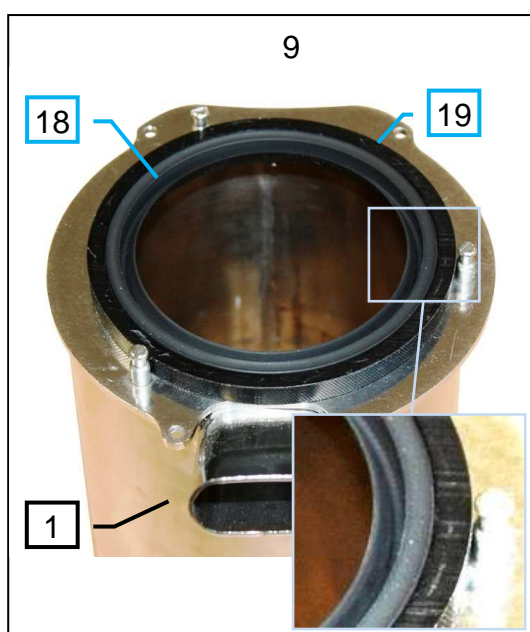
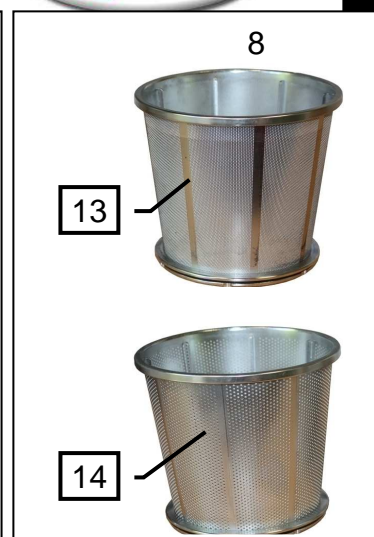
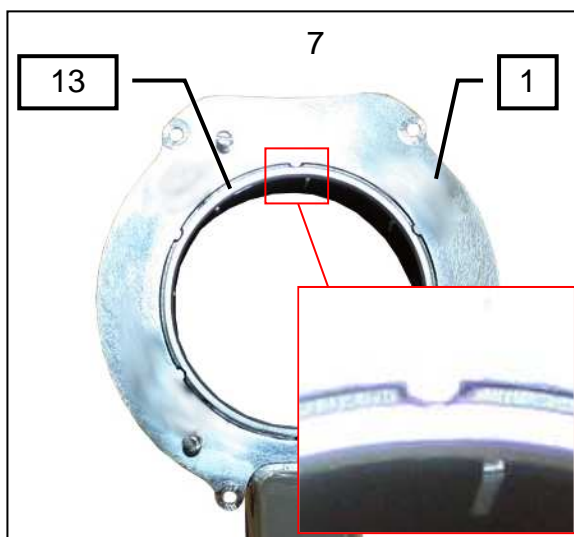
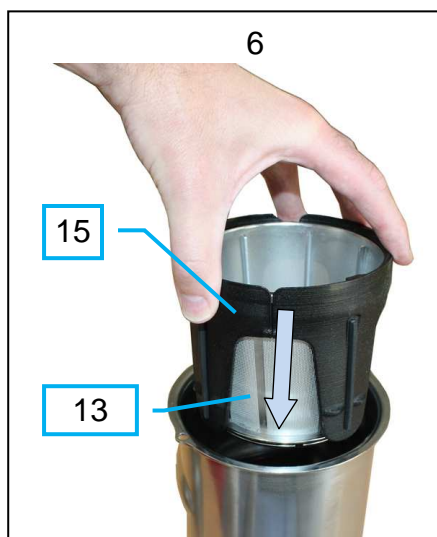

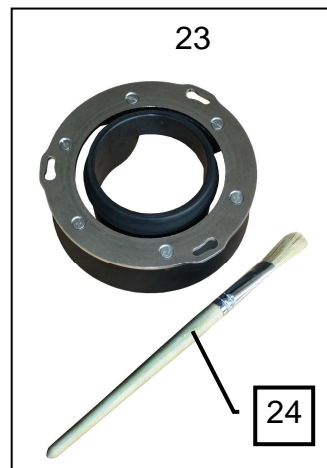
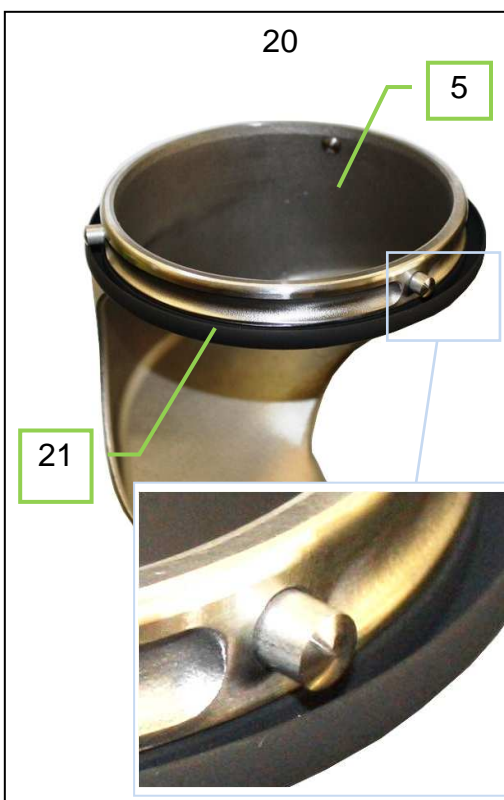
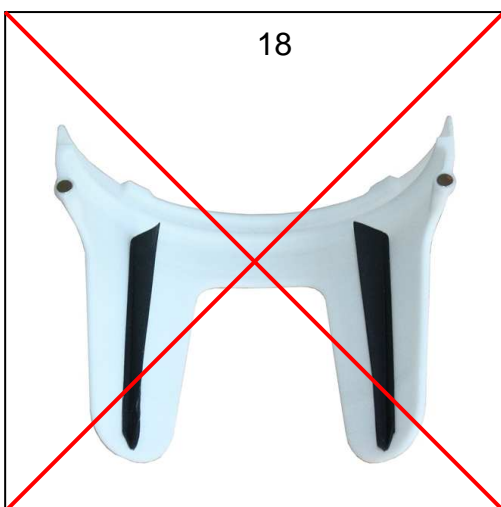
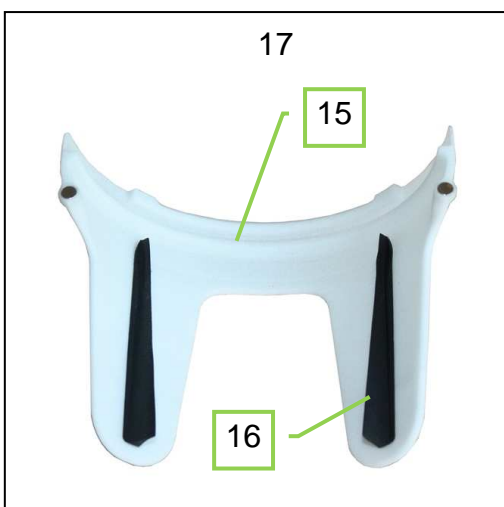
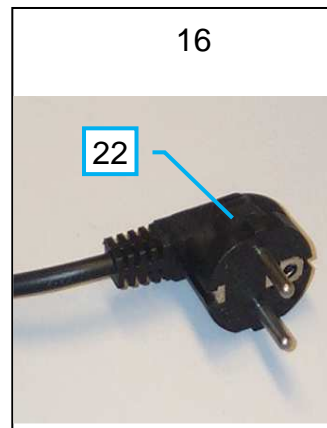



1995 1 1

CE

CE

5

CE

.....

SANTOS

SANTOS

SANTOS

SANTOS

