

AUTOMATIC SILENT ESPRESSO COFFEE GRINDER #40A-40A PPM / #06-06A

USER AND MAINTENANCE MANUAL



IMPORTANT: documents included in this manual to be kept:

- "CE" COMPLIANCE DECLARATION
- WARRANTY CERTIFICATE

Translation of the original version



Model #40A – 40A PPM

Model #06 – 06A

Coffee grinders - Fruit juicers - Mixers - Blenders - Drinks dispensers - Planetary mixers
Cheese graters - Ice crushers - Mincers - Vegetable slicers – Dough mixer
Moulins à café - Presse-fruits - Mixers - Blenders - Distributeurs de boissons - Batteurs
mélangeurs - Pétrin - Râpes à fromage - Broyeurs à glaçons - Hache-viande - Coupe-légumes

MODELES DEPOSES FRANCE ET INTERNATIONAL
INTERNATIONALLY PATENTED MODELS



CONTENTS

“EC” COMPLIANCE DECLARATION	3
IMPORTANT SAFEGUARDS	4
<i>IMPROPER USE</i>	<i>4</i>
<i>ELECTRICAL CONNECTION:</i>	<i>4</i>
<i>USING FOR THE 1st TIME</i>	<i>5</i>
<i>RECYCLING THE PRODUCT AT THE END OF ITS SERVICE LIFE.....</i>	<i>5</i>
YOUR ESPRESSO COFFEE GRINDER #40A - 40APPM, #06 – #06A	6
USING THE MACHINE.....	6
<i>STARTING UP:.....</i>	<i>6</i>
<i>USING:</i>	<i>6</i>
Coffee grinding adjustment:	7
Adjusting the measured dose of ground coffee:	7
<i>CLEANING:.....</i>	<i>8</i>
<i>MAINTENANCE</i>	<i>8</i>
Spare parts:	8
Replacing the grindstones:.....	8
FAULT FINDING.....	10
The machine will not start:	10
The machine stops as a result of motor over-heating: (the motor unit is hot)	10
The machine stops as a result of an overload:	10
The machine stops a few minutes after starting.....	11
The ground coffee measure is not even	11
The ground coffee jams in the grinder body conduit.....	11
The machine runs for a long time without filling the dose measurer	11
MACHINE TECHNICAL SPECIFICATIONS	12
<i>110-120V 50/60Hz wiring diagram</i>	<i>13</i>
<i>220-240V 50Hz wiring diagram</i>	<i>14</i>
<i>220-240V 60Hz wiring diagram</i>	<i>15</i>
<i>Figures.....</i>	<i>17</i>
WARRANTY CERTIFICATE.....	20
APPLIANCE IDENTIFICATION PLATE.....	20

“EC/EU” COMPLIANCE DECLARATION

THE MANUFACTURER:

SANTOS sas - 140-150, Av. Roger SALENGRO 69120 VAULX-EN-VELIN (LYON)
FRANCE

declares that the appliance intended for the professional market described below:

Description: **AUTOMATIC SILENT ESPRESSO COFFEE GRINDER**
Type number: **#40A, 40AC, 40A PPM / #06, 06A, 06AC**

complies with:

- the statutory provisions defined in appendix 1 of the European "machines" directive **n°2006/42/EC** and the national legislation transposing it
- the statutory provisions of the following European directives and regulations:
 - N° 2014/35/EU (low voltage directive)
 - N° 2014/30/EU (EMC directive)
 - N° 2011/65/EU (RoHS directive)
 - N° 2012/19/EU (WEEE directive)
 - N° 1935/2004/EC (regulation) relating to materials and articles intended to come into contact with foodstuffs
 - N° 10/2011/EU (regulation) plastic materials and articles intended to come into contact with food

Harmonised European standards used to give presumption of conformity with the essential requirements of the above-mentioned directives:

- NF EN ISO 12100: 2010, Safety of machinery - General principles for design
- NF EN 60204-1: 2018, Safety of machinery - Electrical equipment of machines-General requirements
- NF EN 1672-2: 2020, Food processing machinery – Basic concepts – Hygiene requirements
- NF EN 60335-1: 2013, Safety of household and similar electrical appliances
- EN 60335-2-64: 2004 Part 2-64, Particular requirements for commercial electric kitchen machines.

Drawn up in VAULX-EN-VELIN on: **01/05/2022**

Signatory's position: **CHIEF EXECUTIVE OFFICER**

Signatory's name: **Aurélien FOUQUET**



Signature:

IMPORTANT SAFEGUARDS

When using, cleaning or maintaining the machine, always follow these instructions:

Read all instructions

Note: For easier understanding of the sections below, please refer to the diagrams at the end of the manual

IMPROPER USE

1. Do not use this appliance for grinding anything other than roasted coffee beans.
2. Never operate the appliance with no coffee beans in the bean container.
3. Remove from the coffee beans any foreign bodies which may damage the grinding wheels (metal staples, stones, etc.).
4. The appliance should neither be cleaned in a jet of water nor with a high pressure spray.
5. For electrocution risk protection reasons, never plunge the base into water or any other liquid.
6. Unplug the appliance before carrying out any work on it: cleaning, maintenance or repair.
7. The use of spare parts other than certified SANTOS original parts is prohibited.
8. Do not use the appliance if the power supply cord is damaged. It must be replaced by either a SANTOS approved dealer or a person with similar qualifications to avoid any danger.
9. Connect several appliances to the same power socket.
10. Do not use the appliance outdoors.
11. Never place the appliance close to or on a source of heat.
12. This appliance is a professional machine designed exclusively for professional use. It is not designed for household use.
13. This appliance is not designed for use by people (including children) whose physical, sensorial or mental capacities are impaired or by people with no experience or knowledge, unless they have been supervised or given training in the use of the appliance beforehand by a person responsible for their safety. Supervise children to ensure they do not play with the appliance.

ELECTRICAL CONNECTION:

- The electric power supply for the machine is available in 3 single-phase voltages:
 - 110-120 V 50/60 Hz
 - 220-240 V 50 Hz
 - 220-240 V 60 Hz

Line protection: the machine should be connected to a standard 2-pole + earth electric socket. The installation should be fitted with an RCD and a fuse rated at 16A. **The appliance must be earthed** (fig. B)

**CARE:**

- Before connecting the machine, check that the mains electrical voltage is the same as the voltage for your appliance. Its value is shown:
 - either on the identification plate (**16**) under the machine.
 - or on the identification plate on the last page of this manual.



- If the power cable (**10**) is damaged, it should be replaced by a SANTOS approved dealer, SANTOS or a person with similar qualifications to avoid any danger.



CARE: Check that the On / Off switch (11) is in the **0 position** before connecting the power cable plug (10) to your mains electric power socket.

USING FOR THE 1st TIME

Carefully clean the parts in contact with the coffee (fig. A).
Take off the lid (1), the bean container (2) and the ground coffee collector (3) and wash them with a standard dish washing product.

RECYCLING THE PRODUCT AT THE END OF ITS SERVICE LIFE

This equipment is marked with the selective sorting symbol relating to wastes from electrical and electronic equipment. It signifies that this product should be taken over by a selective collection system conforming to the Guideline 2012/19/EU (WEEE) – part Professional Equipment – so that it can be either recycled or dismantled in order to reduce any impact on the environment.

For more information, please contact your Retailer or the SANTOS.

For eliminating or recycling components of equipment, please contact a specialized company or contact SANTOS.

The electronic products not undergoing a selective sorting are potentially dangerous for the environment.

The damaging materials should be eliminated or recycled according to the regulations in force.



YOUR ESPRESSO COFFEE GRINDER #40A - 40APPM, #06 – #06A

- The silent bar espresso coffee grinder #40A, #06-06A is designed for bars, cafés, hotels and restaurants. It is suitable for all types of espresso coffee machines.
- Grinder #40A / #6A has, in addition, an automatic start/stop device to ensure a constant level of ground coffee in the distributor.
-
- The machine consists of an aluminium grinder unit and base, a transparent plastic bean container, a dose measurer and a dose counter.
- The machine can be used to grind roasted coffee and to deliver it via an adjustable dose measurer.
- The following adjustments can be made:
 - Adjustment of the grinding fineness (from coarse to espresso)
 - Adjustment of the ground coffee measure (from approximately 5.5g to 9.5g).

USING THE MACHINE

STARTING UP:

Assembly and preparation:

(fig. A)

1. **Model #40A** Clip the ground coffee collector (3) onto the base (4).
2. Put the dose measurer lid (24) in place.
3. Put the bean container (2) in place on the grinder body adjustment nut (5).
4. Pour the roasted coffee beans into the bean container and put the lid on the bean container.
5. Open the bean container shutter (6).

USING:

1. Switch the electric current on to the machine by putting the On / Off switch (11) to **the 1 position** (the motor will start) (fig. B).
2. The coffee beans are then ground by the grindstones and the ground coffee leaves the grinder body and goes to fill the dose measurer.
3. Place the filter-holder under the measurer outlet (23) using the filter-holder support (22) to help.
4. Pull the measurer handle (21) once or twice to deliver one or 2 measure(s) of ground coffee.
5. Remove the filter-holder and tamp down the coffee with the tamper (20) fixed to the dose measurer.

Note: A 5-figure counter on the side of the dose measurer counts each measure.

For #40A / #06A models: the motor stops automatically when the dose measurer is full. It

starts again, after a few measures, when the ground coffee level has dropped sufficiently. Because of this, the machine can be left with the electric power on in **position 1** all the time it is being used.

Coffee grinding adjustment:

Note: Never leave the machine to run with the two grindstones in contact. If the grindstones make contact this may result in ground coffee getting jammed in the grinder body and premature wear of the grindstones.

The machine is factory-set so that the "0" mark on the nut graduated plate (5) relates to the finest grinding without the grindstones touching (fig. C).

1. Hold the adjustment screw (5) with one hand and press the indexing pointer (7) with the other
2. Tighten the adjustment nut by turning in a clockwise direction (right-handed thread) one or two notches for finer grinding.
3. Loosen the adjustment nut by turning in an anti-clockwise direction (right-handed thread) one or two notches for coarser grinding.
4. Release the indexing pointer (7) to retain the grinding adjustment.
5. Draw off a few measures of coffee to check the grinding adjustment.

Depending on the type of coffee used and the fineness of grinding required, the output may drop considerably. A too fine grinding setting may heat up the coffee and alter its flavour.

Adjusting the measured dose of ground coffee:

The dose measurer should be cleaned regularly to prevent conglomerated blocks of coffee on the cross bars from affecting the dose measurer setting.

The machine is factory-set for a measure of approximately 7g.

1. Turn the machine on and allow the dose measurer to fill up.
2. Draw off 4 to 5 measures; the machine should restart.
3. Wait for the machine to stop and then draw off another 5 to 6 measures.
4. Measure the mass (weight) of the measures after that.
5. **Tighten the thumb-wheel (8)** by turning in a clockwise direction (right-handed thread) to **reduce** the quantity of ground coffee per measure (the thumb-wheel is adjusted in half-turns) (fig. D).
6. **Loosen the thumb-wheel (8)** by turning in an anti-clockwise direction (right-handed thread) to **increase** the quantity of ground coffee per measure.
7. **Draw off more than 6 measures** for the adjustment to be taken into account.



CLEANING:

IMPORTANT:

- In every case, the machine should be stopped and the machine's power supply cable (10) unplugged.
- Cleaning with a water spray or pressure spray is not permitted

Clean the dose measurer properly using a brush.

Make sure that the walls of the coffee delivery conduits and the 6 branches of the cross-bars are always clean.

MAINTENANCE

Before carrying out any work on the machine, it is essential to unplug it from the mains and to discharge the motor starting capacitor.



IMPORTANT: Use of spare parts other than certified original SANTOS parts is prohibited

Discharging the capacitor:

- Unscrew the 2 screws located under the machine in the middle of the base plate (fig. E).
- Pull the electrical components unit (20) out of the base plate.
- Using a screwdriver with an **insulated handle**, touch the 2 capacitor connections (15). The sight of an electric arc shows that the capacitor has been discharged.

Spare parts:

This machine requires no specific maintenance. The bearings are lubricated for life. If work is required to replace worn parts such as the grindstones or the electric or other components, refer to the parts list (see exploded view at the end of the manual).

For **all spare part orders** (see references in the exploded view at the end of the manual), state:

- the type,
- the machine serial number and
- the electrical specifications (16)

recorded under the machine.

Replacing the grindstones:



IMPORTANT: always change both 2 grindstones (9) at the same time. (use SANTOS reference 00001B)

The 2 grindstones are identical and can be fitted equally either on the moving plate (18) (moving grindstone) or on the adjusting "nut" (5) (fixed grindstone) (fig. F).

1. Close the bean shutter (6) (fig. G) .
2. Run the machine until the coffee beans waiting in the grinder body have gone through.
3. Stop the machine and unplug the mains power lead (10).
4. Take off the bean container (2).
5. With one hand, press on the **indexing pointer (7)** and with the other unscrew the adjustment nut by turning it in an anti-clockwise direction (fig. H).

CARE: When this part is fully unscrewed, handle it with care so as not to damage the brass thread.

6. Unscrew the 3 screws on each grindstone (fig. I). For the moving grindstone, place a screwdriver across the grinder body and the coffee outlet conduit to stop the grindstone-carrier plate from turning on unscrewing or screwing up the grindstone retaining screws.
7. Carefully clean the whole grinder body, in particular the grindstone facing areas.
8. Place each grindstone on its support making sure that there is no coffee dust between the grindstone and its support.

CARE: *The slightest small coffee particle under the grindstone may prevent the machine from operating correctly. It is recommended that the grinder body is cleaned with a compressed air jet or a dry brush.*

CARE: *do not unscrew the grindstone-carrier plate (18) retaining spindle (17) so as not to upset the assembly geometry (fig. J).*

9. Once the 2 grindstones have been replaced, with one hand press the indexing pointer (7) and with the other place the "ground coffee adjustment nut" (5) on the grinder body taking care not to damage the thread. Without using force, put the "nut" (5) on the grinder body unscrewing it gently to feel for alignment of the two threads and thus to be able to feed them in without using force. Then tighten until the 2 grindstones come into contact (fig. K).
10. Unscrew the "adjustment nut" (5) to free the grindstones in contact.
11. Plug the machine in and switch it on with no coffee.
12. While pressing the indexing pointer with one hand, with the other screw up the "adjustment nut" (5) until the 2 grindstones make **slight** contact.
13. Stop the machine.
14. Unscrew the graduated plate (12) retaining screws and re-index the graduated plate "0" with the indexing pointer (7) (fig. L).
15. Unscrew the "adjustment nut" (5) by 5 to 10 notches
16. With coffee, adjust the ground coffee setting (see "Coffee grinding adjustment" section).

FAULT FINDING

Carefully determine the reason for the machine stopping.

In all circumstances, if the problem persists, disconnect the electric power supply (unplug the mains supply lead plug (10)) and call on someone from the maintenance department or contact an approved SANTOS dealer.

Where appropriate, do not forget to close the bean container shutter (6) before removing the container.

The machine will not start:

- Check: the mains power supply and the condition of the power supply lead (10).
- Check that the On / Off switch indicator (11) lights up when the switch is in the **1** position. If not, replace the switch.
- Check that the grindstones (9) are not making contact preventing the motor from starting.
- Check that there are no foreign bodies stuck between the grindstones.
- Inside the machine, check the condition of the electric wiring and the connections (on the switch (11), on the component support module (20) (fig. N) (the electric components can be accessed without dismantling the machine) and on the dose measurer automatic device unit (19) (fig. M)).
- Check the electric components, replacing them one by one.

The machine stops as a result of motor over-heating: (the motor unit is hot)

The motor is protected by an integral thermal protection. If the motor overheats, it stops.

- Check that there are still coffee beans in the bean container (2).
- Put the On / Off switch (11) to the **0** position and unplug the machine.
- Wait for the motor to cool down (20 to 45 minutes) then press the On / Off switch (11) (position **1**).

The machine stops as a result of an overload:

A foreign body between the grindstones, grindstones making contact, a too fine coffee grinding or intensive operation may result in a motor overload.

Under these circumstances, either the thermal protection or the excess current protection may be activated and stop the machine operating.

If the machine is hot, refer to the section "The machine stops as a result of motor over-heating").

Otherwise:

- Turn off the electric power supply (unplug the mains power lead (10))
- Move the On / Off switch (11) to the **0** position.
- Under the machine (fig. O), press the button (13) to reset the excess current protection. If the button does not remain in the "reset" position, allow the machine to cool down before repeating the operation.

**The machine stops a few minutes after starting.**

- Check the electric components (start relay).

If the problem persists, turn the machine electric power off (unplug the mains power lead (10)) and call on someone from the maintenance department or contact an approved SANTOS dealer.

The ground coffee measure is not even

- Check that there are coffee beans in the bean container
- Clean the coffee dose measurer.

The ground coffee jams in the grinder body conduit

- The machine has perhaps been subjected to a vertical blow (e.g.: during transport), remove the dose measurer and check that the seal between the dose measurer and the grinder body outlet conduit has not come out of its housing.

The machine runs for a long time without filling the dose measurer

- Check that there are coffee beans in the bean container.
- Check that the bean container shutter is in the open position.
- Replace the grindstones.
- Check the dose measurer seal is properly positioned (see previous paragraph).

MACHINE TECHNICAL SPECIFICATIONS



ELECTRIC SPECIFICATIONS (1)			
model		40A -40A PPM	06 – 06A
Supply voltage	(V)	220-240	110-120
Frequency	(Hz)	50/60	50/60
Motor: rating			
Input power	(W)	360	310
Speed:	(rpm)	1450 at 50Hz, 1700 at 60Hz	
Bean container capacity	(kg)	2.2	
Grindstone diameter	(mm)	63.5	
Average output	(kg/h)	8	
Dose measurement adjustment (approx.)	(g)	From 5.5 to 9.5	
Dose measurer capacity	(kg)	0.2	
Automatic start and stop (40A – 40A PPM – 06A only)		Every 3 to 5 measures	
Dimensions: Height	(mm)	580	570
Width	(mm)	190	230
Depth	(mm)	390	250
Weight: Net weight	(kg)	14	10
Packaged weight	(kg)	16	12.5
Noise: (2)	(dBA)	63	72

(1) These values are given as an indication only. The exact electric specifications for your machine are recorded on the identification plate.

(2) Level of noise measured as acoustic pressure with the machine loaded at 1 m from its axis in accordance with standard EN 31201.



220-240V 50Hz wiring diagram

Since 2014

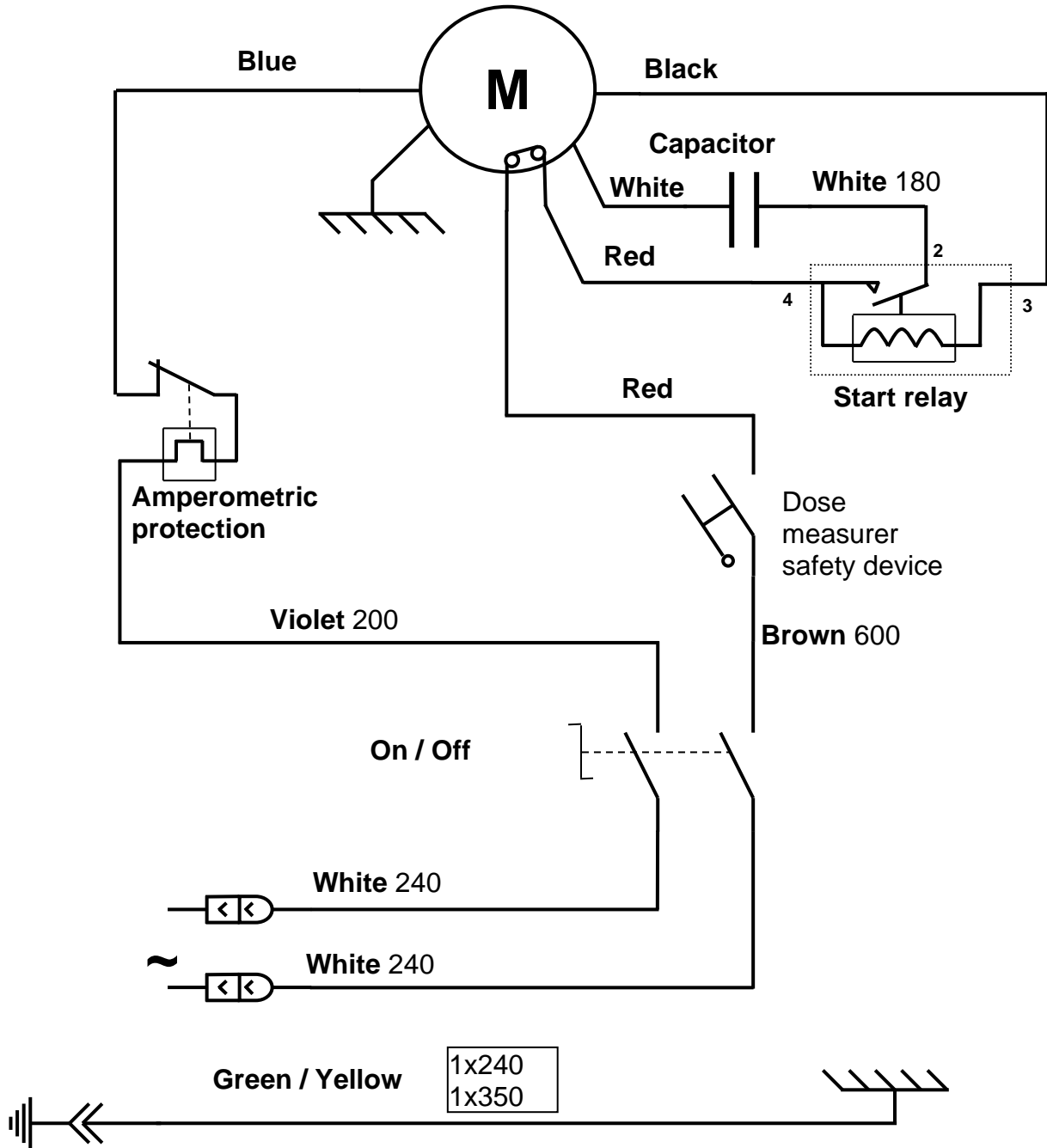



220-240V 60Hz wiring diagram

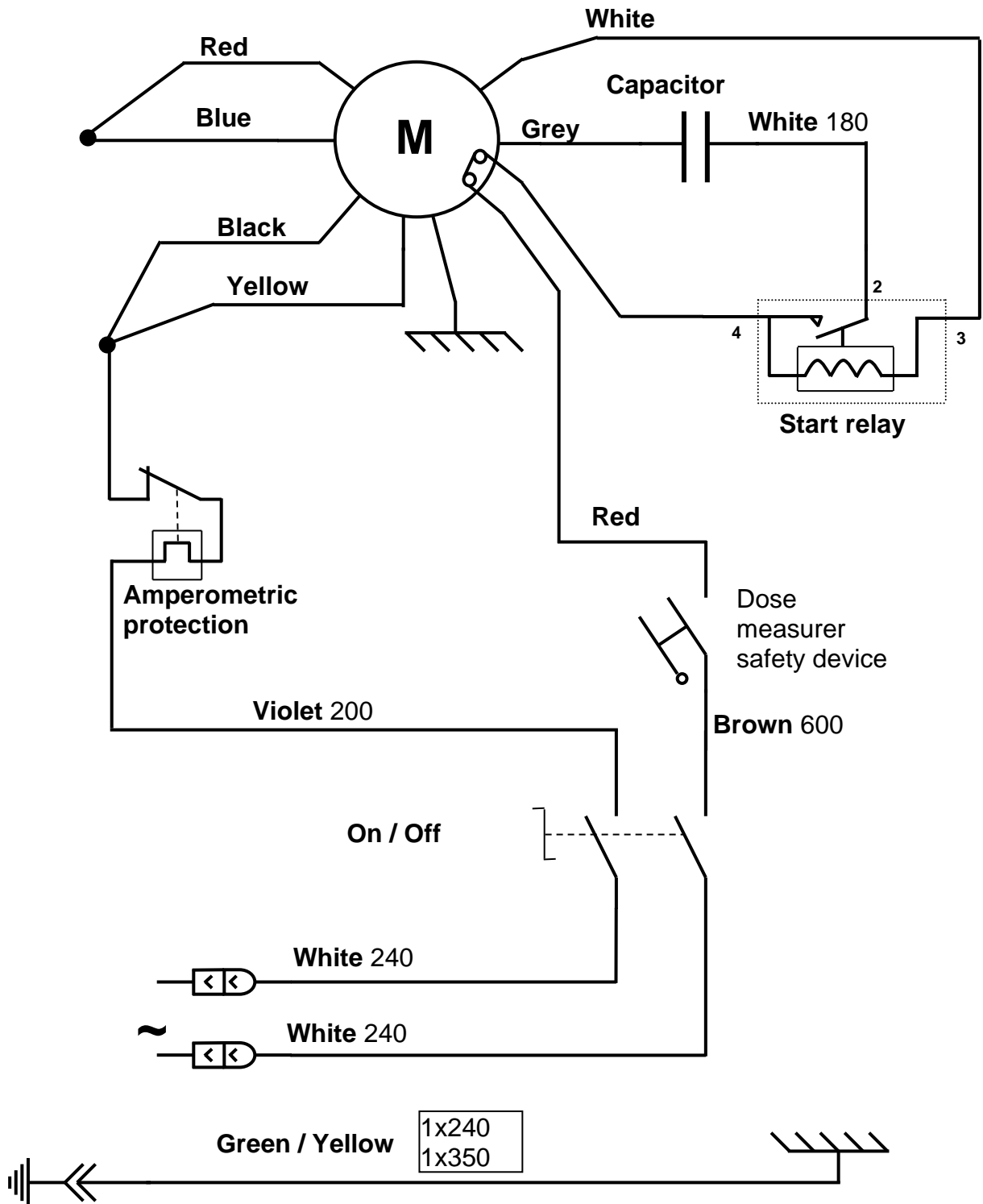

Element cross-reference table

ITEM	Description
1	Bean container lid
2	Bean container
3	Ground coffee collector
4	Base
5	Grinder body
6	Bean container shutter
7	Indexing pointer
8	Coffee measure adjustment thumb-wheel
9	Grindstone
10	Power supply lead plug
11	On / Off switch
12	Graduated plate
13	Excess current protection
14	Start relay
15	Capacitor
16	Identification plate
17	Motor spindle nut
18	Grindstone-carrier plate
19	Automatic device unit
20	Ground coffee tamper
21	Dose measurer handle
22	Filter-holder support
23	Ground coffee output conduit
24	Dose measurer lid

Figures

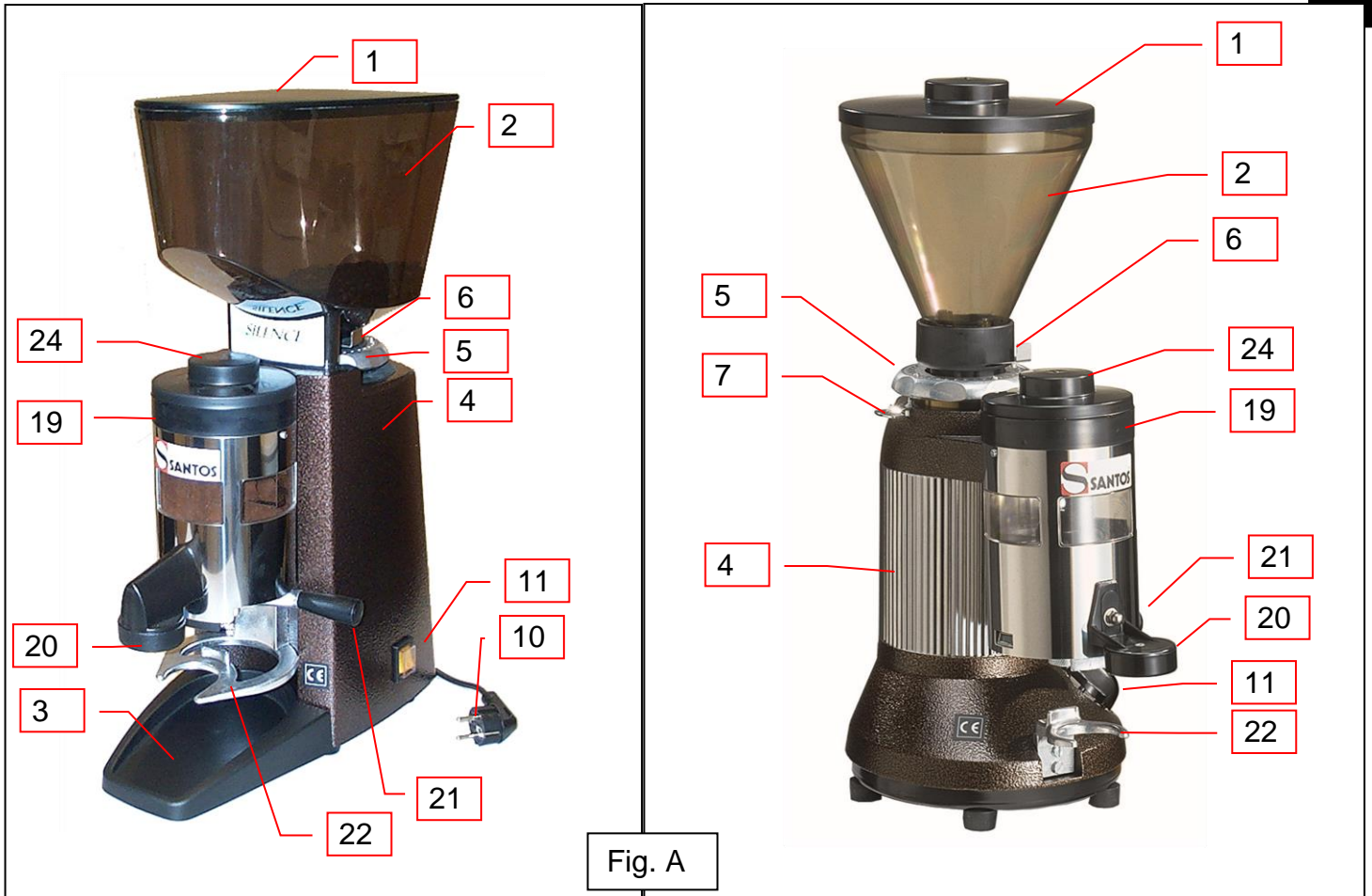

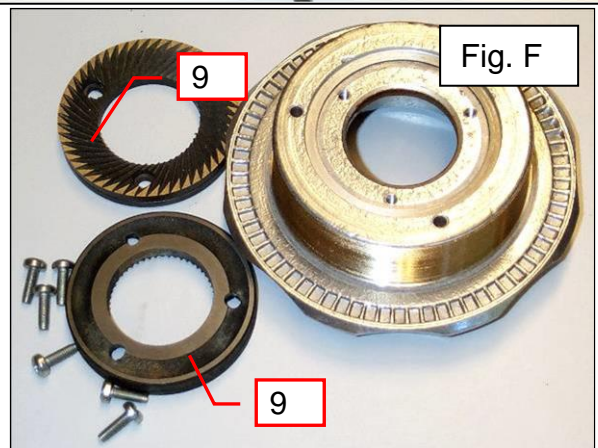
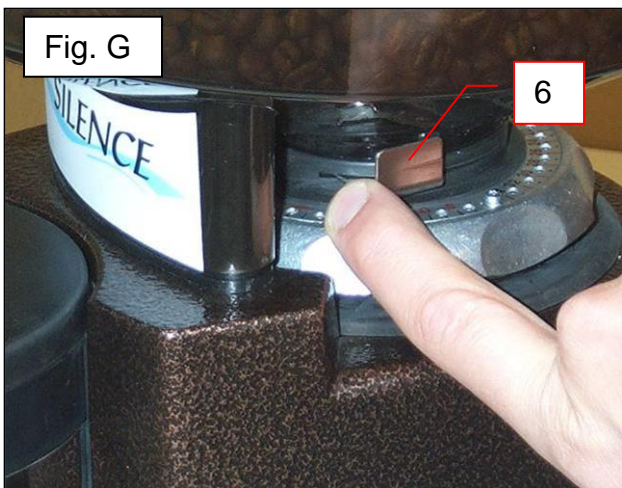
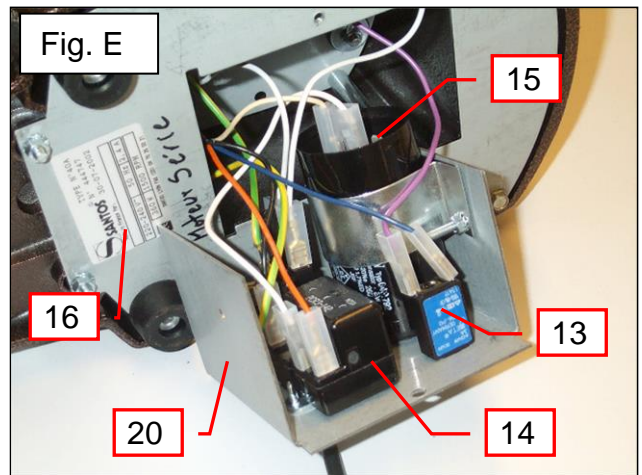
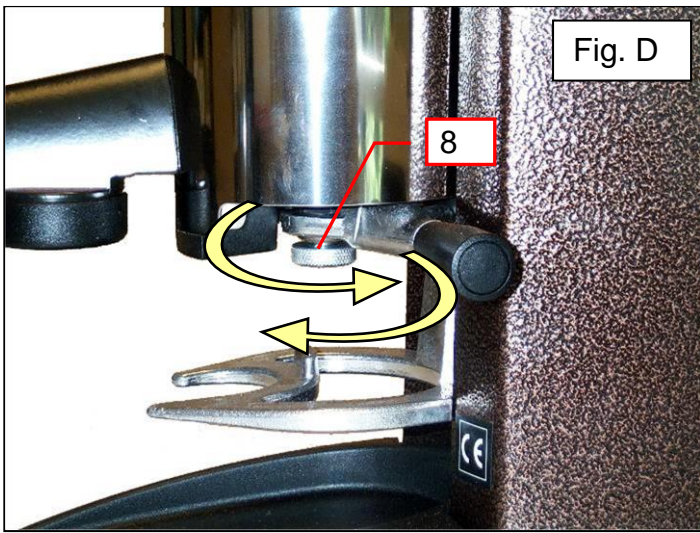
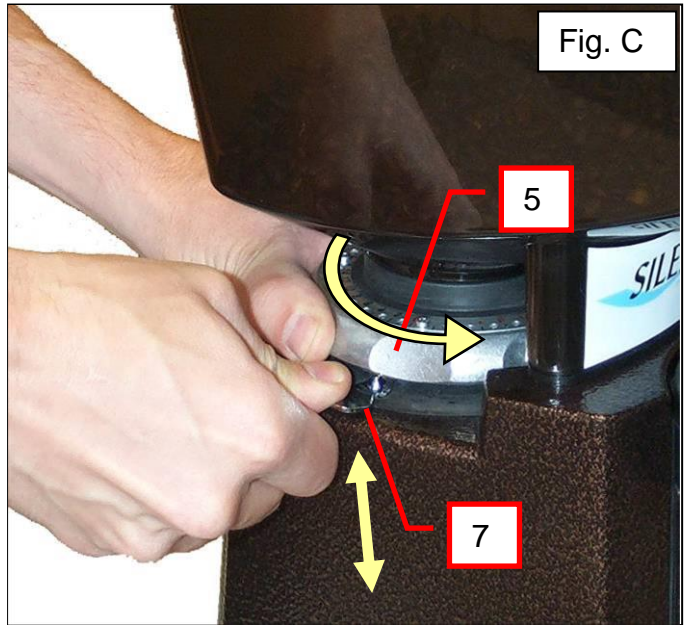
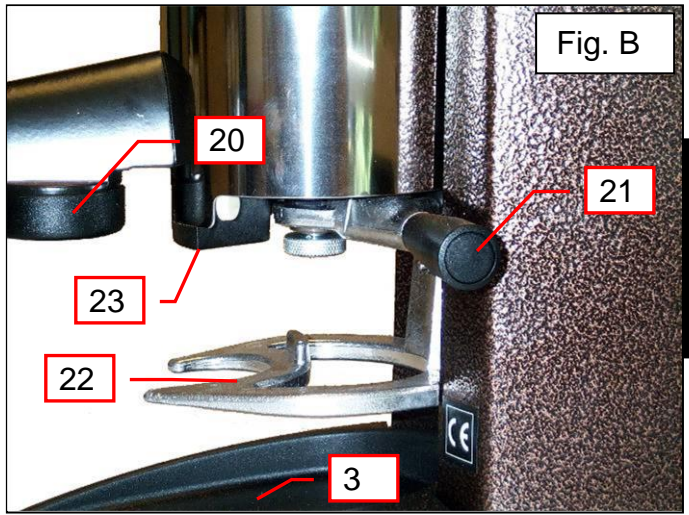
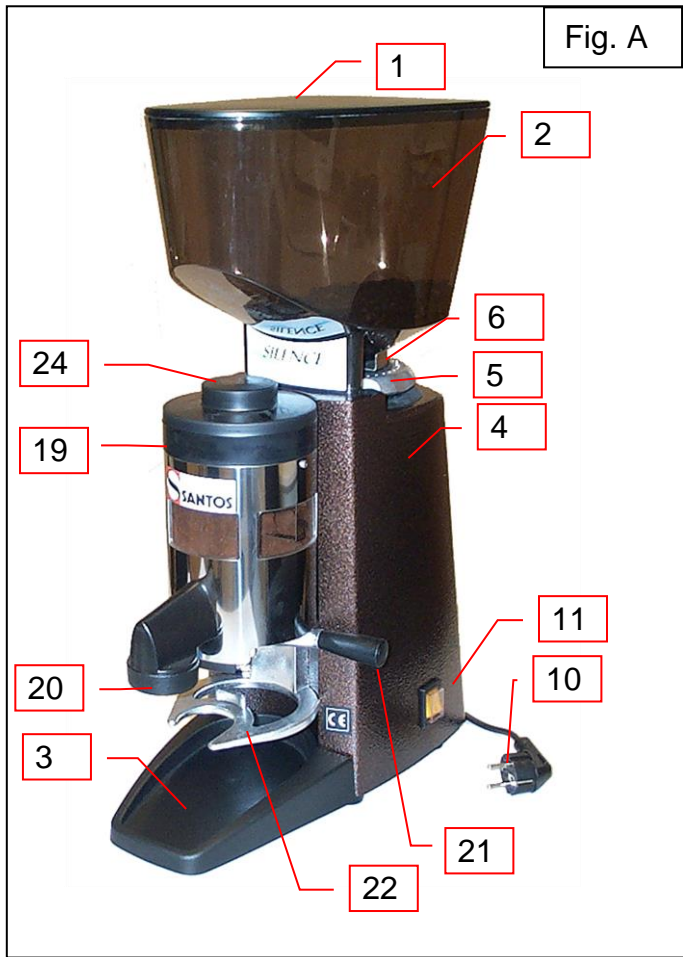

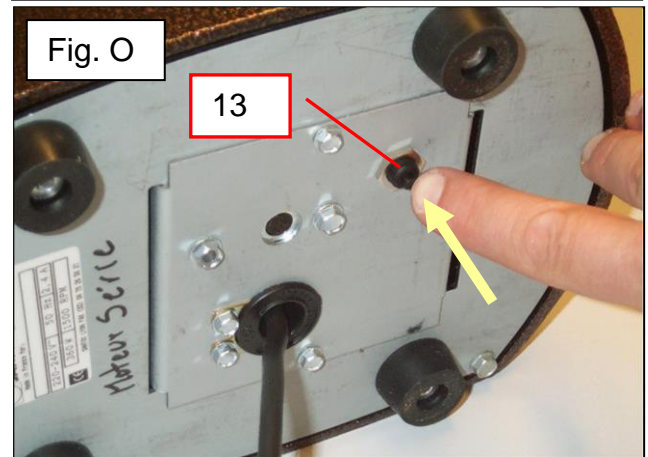
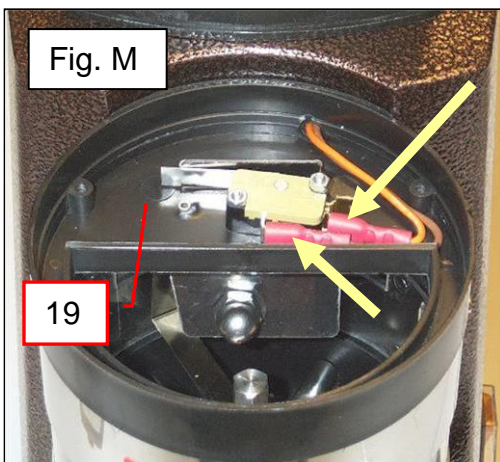
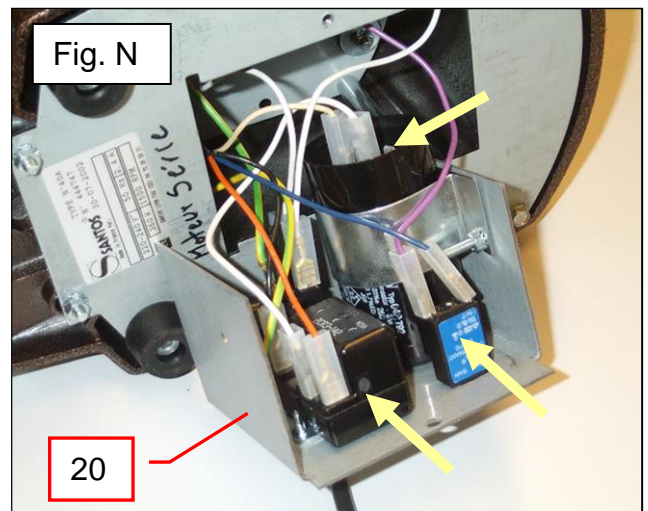
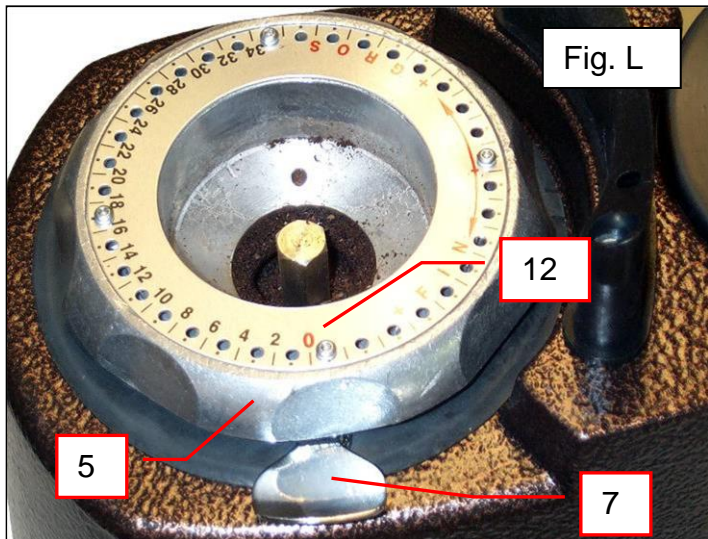
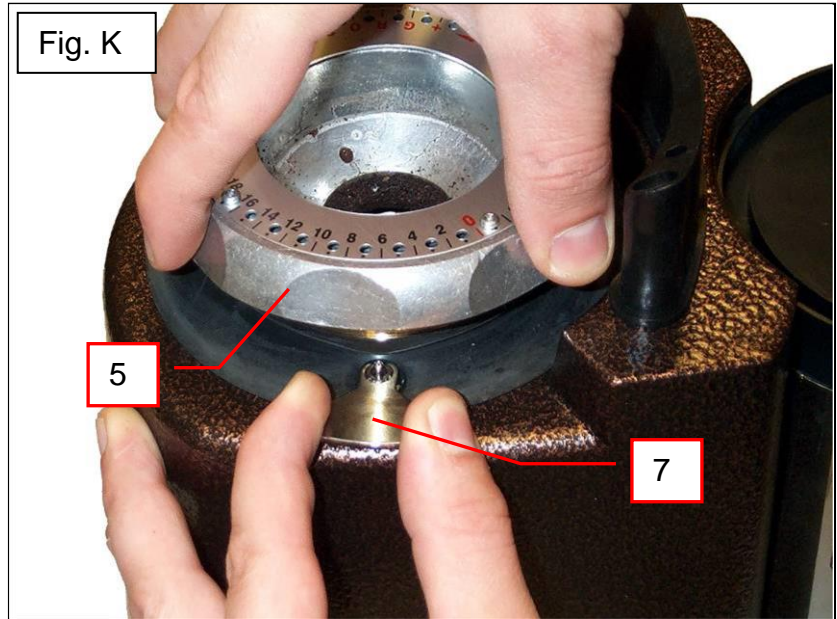
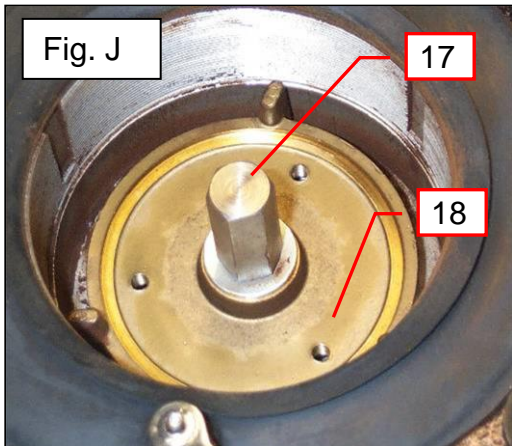
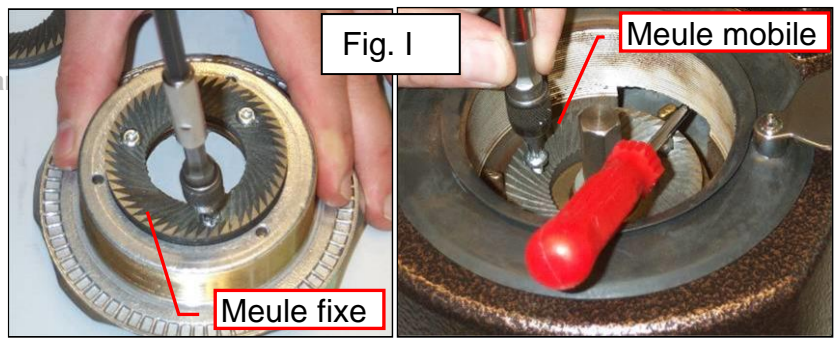
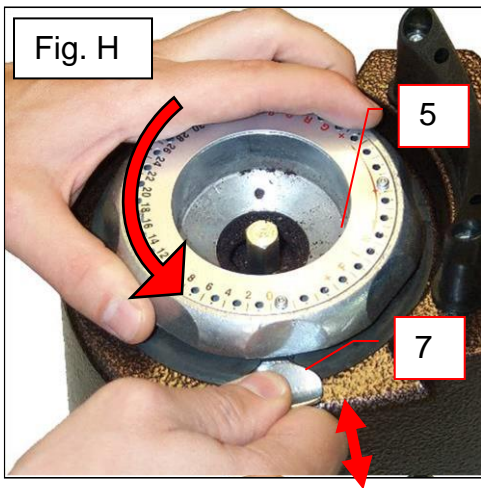

WARRANTY CERTIFICATE

WARRANTY

Since the 01.01.95, all our appliances comply with CE and possess the CE label. Our guarantee is of 24 months from the manufacturing date mentioned on the descriptive plate, except concerning the asynchronous motors (consisting of a rotor and a stator) which are warranted for 5 years from their manufacturing date. Warranty is strictly limited to the free replacement of any part of origin recognized by us as defective due to a defect or building default and identified as belonging to the concerned appliance. Warranty does not apply to damages resulting from installation or use non-complying with our appliance data sheet (user's manual) or in case of an evident lack of maintenance or disrespect of elementary security electric rules. It does not apply in case of regular wear and tear. Any replacement of parts under warranty will be realized after return of the defective part in our workshops, postage paid, supported by a copy of a conformity statement on which appears the serial number of the appliance. Every appliance is equipped with a descriptive plate conforming to the EC recommendations and of which a duplicate exists in the conformity statement (serial number, manufacturing date, electrical characteristics ...). In case of serious damage judged repairable only in our workshops, and after prior consent from our departments, any appliance under guarantee is sent by the Distributor, carriage paid. In case of repairs or reconditioning of appliances not under guarantee, the round trip transport is payable by the distributor. The parts and workforce are invoiced at the current rate. A preliminary estimate can be supplied.

Coffee grinder not using SANTOS original burrs are not taken under guarantee. The warranty conditions, repairs, reconditioning, of the espresso coffee grinder are the object of a specific note. Our guarantee does not extend to the payment of penalties, the repair of direct or indirect damages and notably to any loss of income resulting from the nonconformity or the defectiveness of products, SANTOS's global responsibility being limited to the sale price of the delivered product and to the possible repair of the defective products.

In case of revelation of an imperfection during the warranty period, the Distributor has to, unless a different written agreement of SANTOS, indicate to his customer to stop any use of the defective product. Such a use would release SANTOS of any responsibility.

APPLIANCE IDENTIFICATION PLATE

